



## MagnaPool® (all models)

Hydroxinators are compatible with pH Link and Dual Link modules

### **⚠ WARNING**

**FOR YOUR SAFETY** - This product must be installed and serviced by a licensed electrician in accordance with AS/NZ 3000 - 2007 and any other local applicable regulations. Before installing this product, read and follow all warning notices and instructions that accompany this product. Failure to follow warning notices and instructions may result in property damage, personal injury, or death. Improper installation and/or operation will void the warranty.

Improper installation and/or operation can create unwanted electrical hazard which can cause serious injury, property damage, or death.

## Table of Contents

<p><b>Section 1. Important Safety Instructions ..... 3</b></p> <p><b>Section 2. System Overview ..... 5</b></p> <p>2.1 Contents ..... 5</p> <p>2.2 Specifications ..... 5</p> <p>2.3 Dimensions ..... 6</p> <p>2.4 Materials and Tools ..... 6</p> <p><b>Section 3. Plumbing ..... 7</b></p> <p><b>Section 4. Install Controller ..... 8</b></p> <p>4.1 Mount the Bracket ..... 8</p> <p>4.2 Install temperature sensor ..... 8</p> <p>4.3 Electrical Connections ..... 8</p> <p><b>Section 5. Install the pH Link or Dual Link Module on the Controller ..... 10</b></p> <p>5.1 Install the POD Kit ..... 10</p> <p>5.2 Drill the Pipe ..... 10</p> <p>5.3 Install the POD ..... 10</p> <p>5.4 Install the POD Cap ..... 11</p> <p>5.5 Install and Calibrate the Sensor(s) ..... 11</p> <p>5.6 Install the pH Down Intake and Injection lines ..... 12</p> <p>5.7 Calibration Procedure ..... 13</p> <p><b>Section 6. Prepare and Balance the Pool .... 14</b></p> <p>6.1 Set up the Media Filter ..... 14</p> <p>6.2 Fill and Balance the Pool ..... 14</p> <p>6.3 Starting the System ..... 14</p> <p>6.4 First Two Weeks ..... 14</p> <p>6.5 Water Chemistry Table ..... 15</p> <p>6.6 pH Regulation Principle ..... 15</p> <p>6.7 Stabilizer (Cyanuric Acid) ..... 16</p>	<p><b>Section 7. Operation ..... 16</b></p> <p>7.1 User Interface Overview ..... 16</p> <p>7.2 Initial start-Up ..... 17</p> <p><b>Section 8. Menu and Settings ..... 18</b></p> <p>8.1 Filter Pump ..... 18</p> <p>8.2 Aux/Lights ..... 19</p> <p>8.3 pH Sensor Calibration ..... 20</p> <p>8.4 ORP Sensor Calibration ..... 21</p> <p>8.5 Setpoint(s) ..... 21</p> <p>8.6 Prime and Test the pH Dosing Pump ..... 22</p> <p>8.7 Programming/Timers ..... 22</p> <p>8.8 Reversing ..... 24</p> <p>8.9 Slave Mode ..... 24</p> <p>8.10 Help Menu ..... 25</p> <p><b>Section 9. Inspecting and Cleaning The Electrode ..... 25</b></p> <p><b>Section 10. Winterizing ..... 26</b></p> <p>10.1 Winterize the pH/ORP Sensors ..... 26</p> <p>10.2 Reopening the Pool ..... 26</p> <p><b>Section 11. Troubleshooting ..... 27</b></p>
--	---

Refer to the following websites for information on warranty and service in your country

For Australia, NZ, Asia and Sth Pacific go to [www.zodiac.com.au](http://www.zodiac.com.au)

<b>EQUIPMENT INFORMATION RECORD</b>	
<b>DATE OF INSTALLATION</b> _____	
<b>INSTALLER INFORMATION</b> _____	
<b>INITIAL PRESSURE GAUGE READING (WITH CLEAN FILTER)</b> _____	
<b>PUMP MODEL</b> _____	<b>HORSEPOWER</b> _____
<b>FILTER MODEL</b> _____	_____
<b>CONTROL PANEL MODEL</b> _____	<b>SERIAL NUMBER</b> _____
<b>NOTES:</b> _____	
_____	

## Section 1. Important Safety Instructions

# READ AND FOLLOW ALL INSTRUCTIONS

All electrical work must be performed by a licensed electrician and conform to all national, state, and local codes. When installing and using this electrical equipment, basic safety precautions should always be followed, including the following:

### ⚠ DANGER

To reduce the risk of severe injury or death, do not remove the suction fittings of your spa or hot tub. Never operate a spa or hot tub if the suction fittings are broken or missing. Never replace a suction fitting with one rated less than the flow rate marked on the equipment assembly.

### ⚠ WARNING

Prolonged immersion in hot water may induce hyperthermia. Hyperthermia occurs when the internal temperature of the body reaches a level several degrees above the normal body temperature of 37°C. The symptoms of hyperthermia include dizziness, fainting, drowsiness, lethargy, and an increase in the internal temperature of the body. The effects of hyperthermia include: 1) unawareness of impending danger; 2) failure to perceive heat; 3) failure to recognize the need to exit spa; 4) physical inability to exit spa; 5) fetal damage in pregnant women; 6) unconsciousness resulting in a danger of drowning.

### ⚠ WARNING

#### To Reduce the Risk of Injury -

- a) The water in a spa should never exceed 40°C. Water temperatures should remain between 38°C and 40°C. The water in a spa should never exceed 40°C. Water temperatures between 38°C and 40°C are considered safe for a healthy adult. Lower water temperatures are recommended for young children and when spa use exceeds 10 minutes.
- b) Since excessive water temperatures have a high potential for causing fetal damage during the early months of pregnancy, pregnant or possibly pregnant women should limit spa water temperatures to 38°C. Before entering a spa or hot tub, the user should measure the water temperature with an accurate thermometer since the tolerance of water temperature-regulating devices varies.
- d) The use of alcohol, drugs, or medication before or during spa or hot tub use may lead to unconsciousness with the possibility of drowning.
- e) Obese persons and persons with a history of heart disease, low or high blood pressure, circulatory system problems, or diabetes should consult a physician before using a spa.
- f) Persons using medication should consult a physician before using a spa or hot tub since some medication may induce drowsiness while other medication may affect heart rate, blood pressure, and circulation.

### ⚠ WARNING

**Risk of electric shock** - Install the controller at least 3.5 metres from the inside wall of the pool and/or hot tub using non-metallic plumbing.

Children should not use spas or hot tubs without adult supervision.

Do not use spas or hot tubs unless all suction guards are installed to prevent body and hair entrapment.

People using medications and/or having an adverse medical history should consult a physician before using a spa or hot tub.

### ⚠ WARNING

To avoid injury ensure that you use this control system to control only packaged pool/spa heaters which have built-in operating and high limit controls to limit water temperature for pool/spa applications. This device should not be relied upon as a safety limit control.

## ⚠ WARNING

People with infectious diseases should not use a spa or hot tub.

To avoid injury, exercise care when entering or exiting the spa or hot tub.

Do not use drugs or alcohol before or during the use of a spa or hot tub to avoid unconsciousness and possible drowning.

Before entering a spa or hot tub, measure the water temperature with an accurate thermometer.

Do not use a spa or hot tub immediately following strenuous exercise.

Prolonged immersion in a spa or hot tub may be injurious to your health.

Do not permit any electric appliance (such as a light, telephone, radio, or television) within 3.5 metres of a spa or hot tub.

The use of alcohol, drugs or medication can greatly increase the risk of fatal hyperthermia in hot tubs and spas.

Water temperature in excess of 38°C may be hazardous to your health.

## ⚠ WARNING

A terminal bar marked "GROUND" is provided within the controller. To reduce the risk of electrical shock which can cause serious injury or death, connect this terminal bar to the grounding terminal of your electric service or supply panel with a continuous copper conductor having green insulation and one that is equivalent in size to the circuit conductors supplying this equipment in accordance with AS/NZ 3000 - 2007. In addition, where required, bonding should be extended in accordance with AS/NZ 3000 - 2007 to any metal ladders, water pipes, or other metal within 3.5 m of the pool/spa.

## ⚠ CAUTION

Power to the Aqualink TRI should be supplied by an isolating transformer or through a residual current device (RCD) with a rated residual operating current not exceeding 30mA.



**Attention Installer:** Install to provide drainage of compartment for electrical components.

# SAVE THESE INSTRUCTIONS

## Section 2. System Overview

### 2.1 Contents

Before starting, check that you have the correct parts as indicated in Table 1. If any parts are missing or incorrect, please call your local distributor or technical support at 1300 763 021 for assistance.

#### 2.1.1 Hydroxination System



Clearwater, eXO®, Hydroxinator (all models)	
a.	Controller
b.	Temperature Sensor*
c.	Wall Mount Bracket
d.	Wall Mount Screws Ø7 mm (X2)
e.	Wall Mount Anchor (X2)
f.	Electrolytic Cell
g.	Unions (X2)
h.	Glue on Adapter (X2)
i.	Adapter O-Rings (X2)
j.	Pipe Reducer - White (X2)
k.	Zip Ties (X7) - (not shown)

\*Items not included with all models.

Table 1. Hydroxination System Contents

## 2.2 Specifications

#### 2.2.1 Hydroxination System

	Compact	Mid	Large
Nominal chlorine production	18 g/h	25 g/h	35 g/h
Nominal output amps	3.6 A	5.0 A	7.2 A
Required mineral level	4000ppm		
Power supply voltage	240 VAC - 50 Hz		
Electric power	200 W		
Protection index	IP43		
Flow through the cell	Min. 80 Lpm		
Max pressure in the cell	2.75 bar		
Operating water temperature	10°C - 40°C		

Table 3. Hydroxination System Specifications

#### 2.1.2 Water Care Module Contents



pH Link, Dual Link	
a.	Module (pH Link or Dual Link)
b.	POD Housing Upper
c.	POD Housing Lower
d.	40 mm Pipe Adapter
e.	POD Cap
f.	Cap Plug (X2)
g.	pH Injector Valve
h.	Hole Saw and Hex Key
i.	Compression Fitting
j.	Ceramic Weight
k.	6 mm Tube (5 m)
l.	Acid Cap, 5 L
m.	Acid Cap, 15/20 L
n.	Locking Collar
o.	Locking Collar Tool
p.	pH Sensor
q.	ORP Sensor*
r.	Sensor Holder (X2*)

**NOTE:** Water care modules are optional accessories and will not be included with all models.

\*Items only included with eXO® - Pro iQ  
 pH Buffer Solutions: pH 7 (X6), pH 4 (X6) - (not shown)  
 ORP 470 mV Buffer Solution (X6) - (not shown)

Table 2. Water Care Module System Contents

#### 2.2.2 Water Care Module

Power Supply	Extra low voltage (connected to controller)
Peristaltic pump flow rate	1.2 L/h
Maximum back pressure (injection)	1.5 bar
pH correct	Acidic pH only (sulfuric/hydrochloric acid)
pH sensor calibration	1 or 2 point (pH 4 and pH 7)
Sensor Cable Length	3 Meters
ORP sensor calibration*	1 point (470 mV)

\*Applicable only to eXO® - Pro iQ

Table 4. Water Care Module Specifications

## 2.3 Dimensions

### 2.3.1 Controller

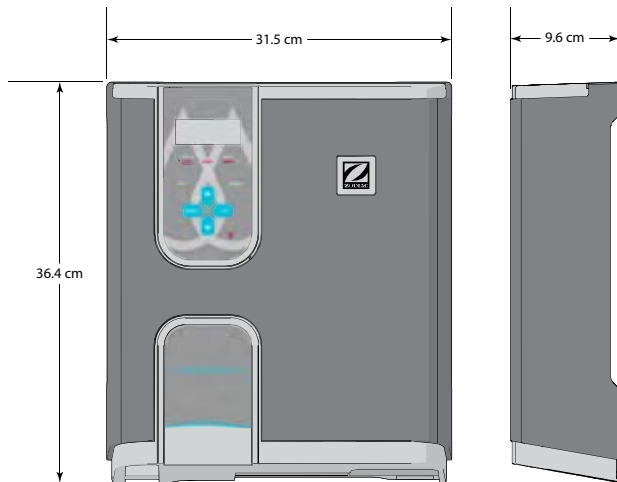

Figure 1. Controller Dimensions

### 2.3.2 Cell

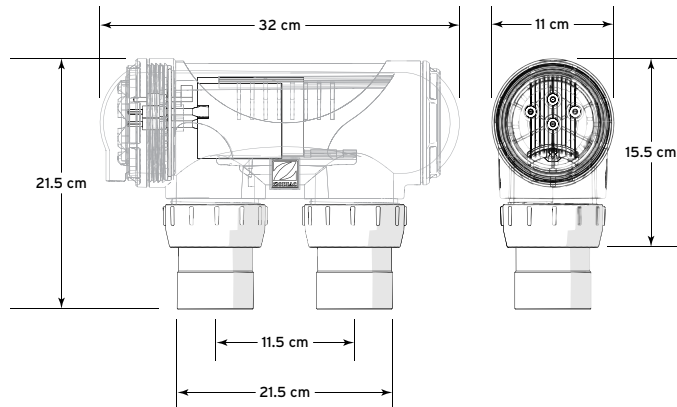

Figure 2. Electrolytic Cell Dimensions

## 2.4 Materials and Tools

### 2.4.1 Controller

#### Tools Needed for Installation

- Power Drill
- 7 mm Drill Bit - Hammer Drill Bit (only necessary to drill into brick or concrete)
- Pencil or Marking Pen
- Flat Head Screwdriver
- Pozidiv Screwdriver
- Small Flathead or Slotted Screwdriver

### 2.4.2 Cell

#### Tools Needed for Installation

- PVC Cutter
- PVC Cement
- Pencil or Marking Pen
- Check Valve
- 40 mm or 50 mm PVC pipe

### 2.4.3 pH ORP POD

#### Tools Needed for Installation

- Power Drill
- Pencil or Marking Pen
- Flat Head Screwdriver
- Phillips Head Screwdriver
- Small Flathead or Slotted Screwdriver

## Section 3. Plumbing

The cell must be plumbed in a position that is accessible for maintenance and within 2 meters of the controller. The cell should be the last piece of equipment in the circulation system. The cell must be installed horizontally, level and with correct flow orientation, see Figure 3 and Figure 4.

1. If you intend to plumb the cell on a bypass, the bypass must be equipped with Isolation valves, see Figure 3 and Figure 4.
2. Plumb the cell inlet and outlet on vertical lengths of 40 mm or 50 mm PVC pipe. The cell inlet and outlet ports are 11.5 cm apart, see Figure 2. The inlet of the cell is on the side closest to the electrical lead, see Figure 5.

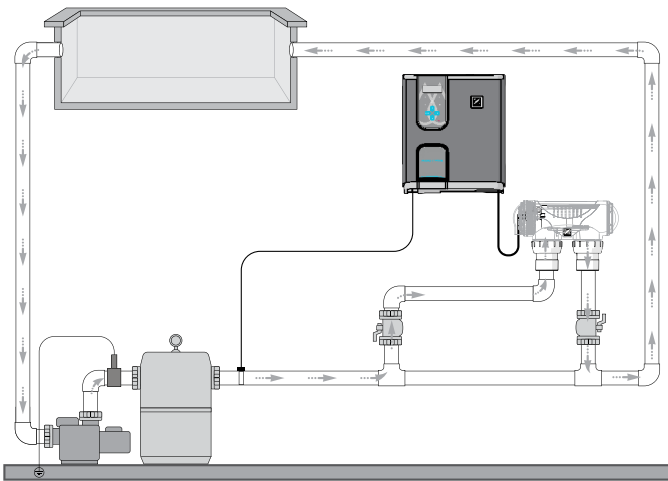

Figure 3. Plumbing Cell Only

3. Put the unions onto the inlet and outlet pipes, see Figure 5.
4. For 50 mm plumbing, glue the adapters directly onto the pipes.
5. For 40 mm plumbing, glue the reducers into the adapters then glue the adapters onto the pipes.
6. Ensure the o-rings are seated properly on the adapters.
7. Secure the cell to the plumbing by tightening the unions hand tight. DO NOT OVERTIGHTEN.
8. Double check cell orientation. The cell inlet is closest to the cell electrical lead.

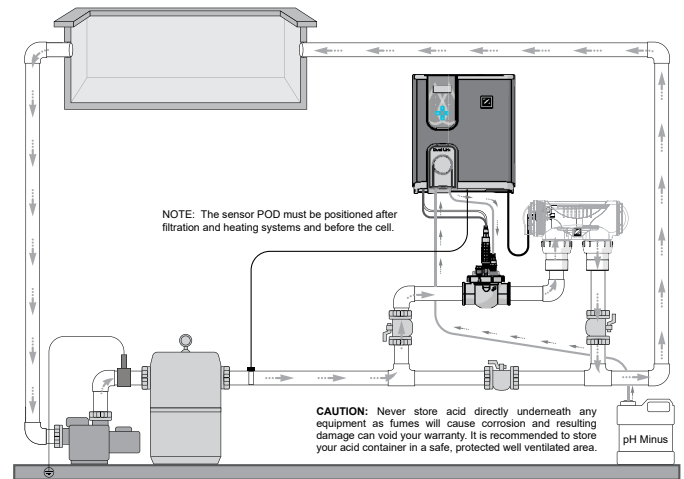

Figure 4. Plumbing Cell and POD assembly



Figure 5. Cell Plumbing Assembly

### ⚠ WARNING

- The cell must be installed horizontally and level. Improper installation can lead to gas build up which could result in equipment damage or serious injury.
- The cell must be the last piece of equipment on the return line, see Figure 3 and Figure 4.
- It is recommended in all installations that the cell is installed on a bypass equipped with isolation valves, see Figure 3 and Figure 4.
- In order to avoid load loss, installing the cell on a bypass is **MANDATORY** if system flow rated exceeds 300 Lpm, see Figure 3 and Figure 4.
- If installing on a bypass, use a downstream check valve instead of a manual valve to prevent improper back flow into the cell.



## Section 4. Install Controller

The controller should be located at or near the equipment pad, at least 3.5 metres or more away from the inside wall of the pool/spa, 1.5 metres off the ground, and within 2 meters of the cell. All national, state, and local codes are applicable.

### 4.1 Mount the Bracket

1. Determine the controller location.
2. Use the enclosed bracket to mark the mounting surface through the screw holes.
3. Drill surface with 7 mm bit.
4. Install the included wall anchors.
5. Hang bracket using the included screws.
6. Hang the controller on the wall bracket and slide to the right to secure in place.



Figure 6. Controller Mount

### 4.2 Install temperature sensor

The temperature sensor must be installed upstream from any heating equipment, see Figure 3 and Figure 4. The sensor will need to be placed into the plumbing system at any suitable position after the filter pump and before any heating equipment.

1. Drill a  $\text{Ø}9$  mm hole in the top of the pipe.
2. Ensure the o-ring is properly seated on the sensor body.
3. Secure the sensor and o-ring with the screw clamp provided. **DO NOT OVERTIGHTEN.**

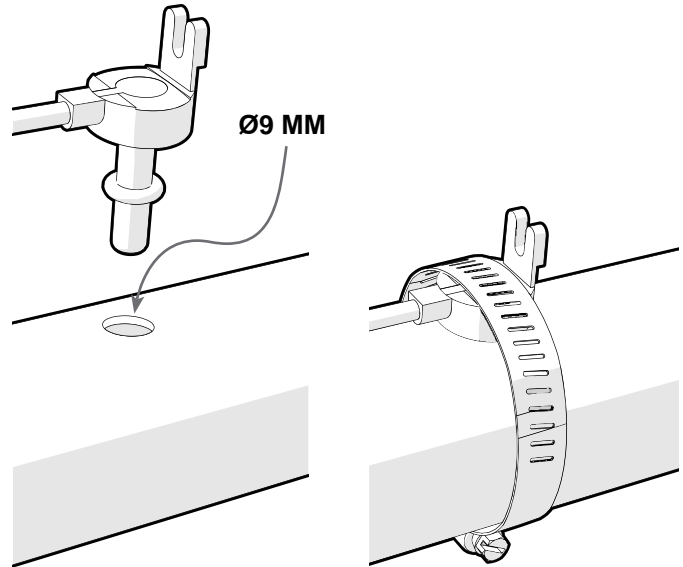

Figure 7. Install Temperature Sensor

### 4.3 Electrical Connections

#### ⚠ WARNING

**FOR YOUR SAFETY:** This product must be serviced by a professional pool/spa service technician as described on the front cover of this manual. The procedures in this manual must be followed exactly. Failure to follow warning notices and instructions may result in property damage, serious injury, or death. Improper installation and/or operation will void the warranty.

The controller must be permanently powered by connection to a 30 mA residential circuit breaker.

The controller can be used to connect and control multiple devices see Table 5 for a summary of functions.

#### 4.3.1 Remove Lower Cover

1. Unplug power supply from mains.
2. Remove the external cover.
3. Remove the 2 screws from the lower housing.
4. Remove the lower housing by pulling down then out see Figure 8.



Figure 8. Remove Controller Lower Cover



### 4.3.2 Controller Enclosure Wiring

1. Wire low voltage connections on the low voltage side of the enclosure, see Figure 10.
2. Wire high voltage connections on the high voltage side of the enclosure, see Figure 10.
3. Use the internal labels (low voltage - yellow, high voltage - orange) to identify connection points.
4. Use the cable ties provided to secure internal wiring to the controller frame. See Figure 10 for recommended cable tie locations and Table 5 for connection point functions.
5. Pass cables through the appropriately labeled strain relief ports. It may be necessary to pierce the strain relief grommet prior to passing the cables through it.

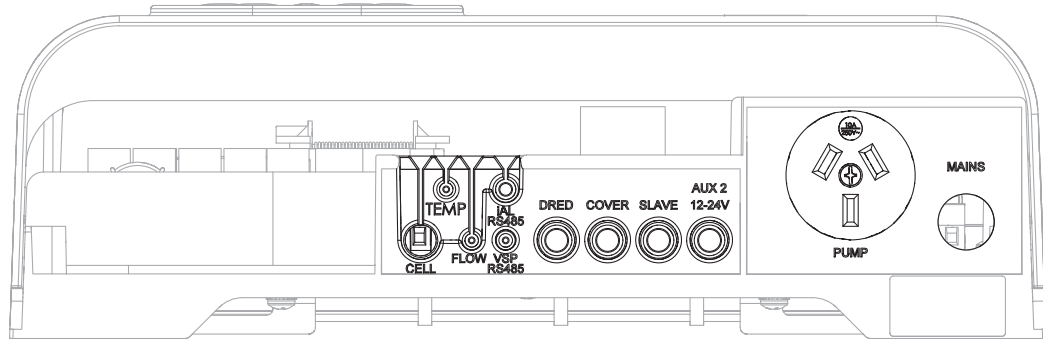

Figure 9. Controller Connection Ports

NAME	TYPE	ROUTE	FUNCTION
SENS	Input	-	Connection of the pH or pH/ORP sensing PCBA
PUMP	Input	-	Connection of the pH pump for pH Link and Dual Link modules
CELL	Output	1	Connection of the electrolysis cell
UI	Output	-	Connection of the user interface
TEMP	Input	3	Connection of the water temperature probe
Flow	Input	2	Not used in AUS / South Africa
iAL RS485	Input	4	Connectivity dedicated connector
VSP RS485	Output	5	RS485 variable speed pump connection
DRED	Input	6	DRED Funtion (Demand Response Enabled Device) – for Australia only
COVER	Input	7	Pool cover contact – lower the chlorine production (dry contact: cover open = open contact/cover closed = closed contact)
SLAVE	Input	8	External connection of a device controlling the hydroxinator
AUX 2 12-24V	Output	9	ON/OFF control of a LOW VOLTAGE external device (12 – 24V)
AUX 1 230V	Output	10	ON/OFF control of a HIGH VOLTAGE device. - Not available in Australia
PUMP 230V	Output	11	230 V Power supply for the filtration pump Maximum 8A
MAINS	Input	12	Device power supply 230 VAC – 50Hz

Table 5. Controller Wiring Positions

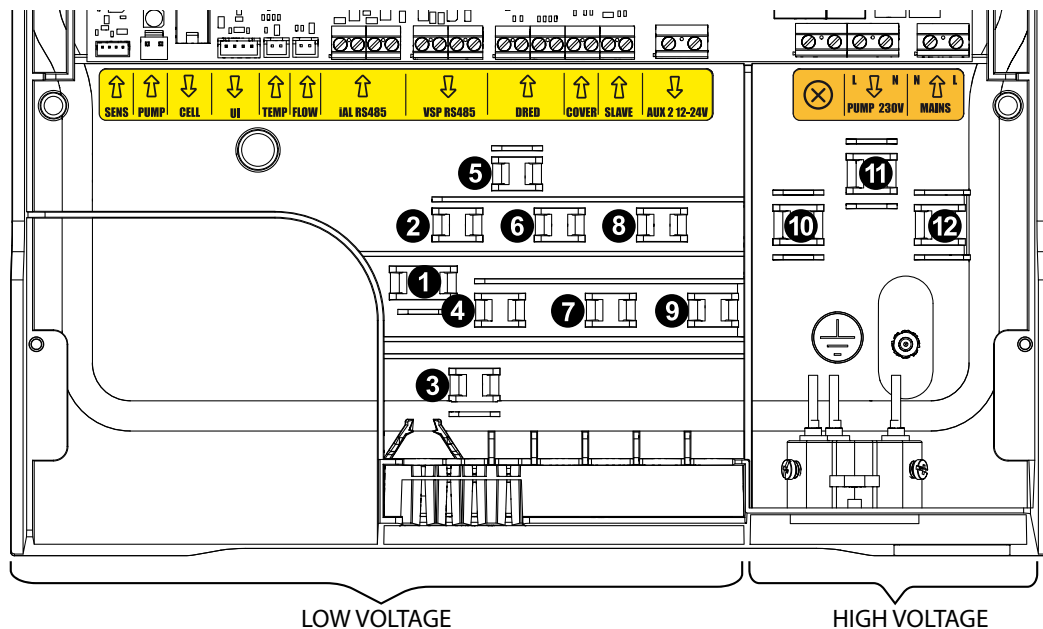

Figure 10. Controller Wiring

## Section 5. Install the pH Link or Dual Link Module on the Controller

**NOTE:** Water care modules are optional accessories and will not be included with all models.

If your controller model does not have a Dual-Link or pH Link module you may skip to Section 6.

The controller must be installed and operational before you install the module, refer to Section 4.

pH balance and suitable alkalinity levels in the water must be maintained. Be sure to prepare and balance the pool before installing the pH Link or Dual Link module, for details see Section 6.

1. **⚠** Turn OFF and disconnect all power to the controller.
2. Remove the front cover from the controller, see section 4.3.1 for details.
3. Connect Sens and Pump wires from the Module to the controller board see section 4.3 for wiring details.
4. Seat the Module housing on the controller.
5. Fasten two screws to secure the module to the controller.
6. Replace the external cover.

**Figure 11. Dual Link Module Installed**

### **⚠ WARNING**

Do not reconnect power supply until all components are installed: (1) pH Link/Dual Link module, (2) POD kit, and (3) pH down injection pipe.

### 5.1 Install the POD Kit

1. **⚠** Turn off and disconnect all power to the controller.
2. For optimal performance, the POD must be installed:
  - On a 30 cm length of rigid 40 mm or 50 mm PVC pipe.
  - As far as possible from any angles.
  - Horizontally.
  - Vertically within 30°.
  - After the filtering equipment.
  - After any heating device but before the electrolytic cell or other water treatment equipment.

### 5.2 Drill the Pipe

1. Inspect the POD O-ring to ensure it is in good condition and properly seated.
2. Press tabs to remove the upper POD housing from the lower POD housing.

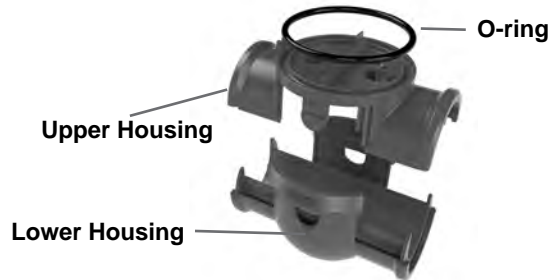
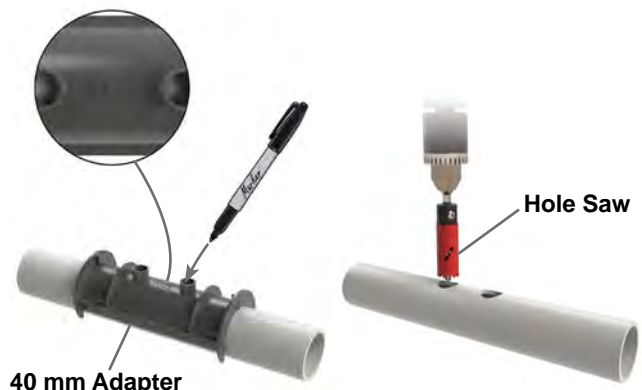

**Figure 12. POD Assembly**

3. Remove the 40 mm adapter from the lower POD housing.
4. Place the 50 mm guide on the top of the pipe.

**NOTE:** For 40 mm installations use the 40 mm adapter marked "AUS" as the guide for marking the pipe, for 50 mm installations use just the bottom of the POD assembly.

5. Mark the pipe through the holes.
6. Drill holes in the PVC pipe using the hole saw. Make sure the edges are smooth without burrs.



**Figure 13. Mark and Drill Pipe**

### 5.3 Install the POD

1. For 40 mm pipe installations, insert the adapter into the holes in lower POD housing.



**Figure 14. Assemble the POD**

2. Note the arrows on the upper housing indicating flow direction. Make sure the pod is in proper orientation.

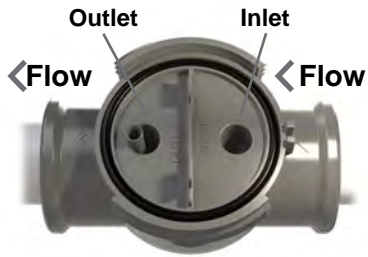

**Figure 15. POD Orientation**

3. Assemble the POD around the pipe, the tabs will click into place.

#### 5.4 Install the POD Cap

1. Place the POD cap on the POD assembly. The cover and POD assembly are keyed for proper orientation. Use caution to ensure the POD O-ring is clean and properly seated.
2. Align the arrow on the POD with the locking ring.



**Figure 16. POD Locking Ring Orientation**

3. Tighten the locking ring with the locking collar tool until snug. Do not overtighten.

#### 5.5 Install and Calibrate the Sensor(s)

1. Install the sensor holder(s) into the correct port on the POD cap. Remove the cap plug if necessary.

**NOTE:** The ORP sensor is with Dual Link module only.

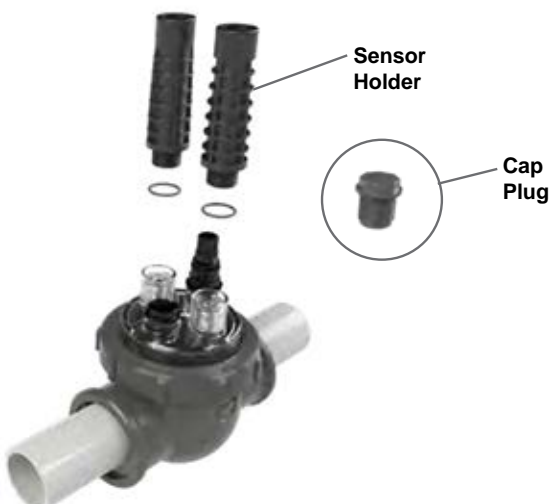

**Figure 17. Sensor Holder Installation**

2. Carefully remove the protective tube from the sensor.
3. Rinse the end of the sensor with tap water. Shake off excess water.
4. Carefully screw the sensor(s) into sensor holder.



**Figure 18. pH/ORP Sensor Installation**

5. Calibrate the sensor(s).  
(See Section 5.7. Calibration Procedure)

To maintain accurate and reliable operation, the sensors must be calibrated before the initial use of the controller with pH/Dual Link module. After initial calibration, it is recommended to recalibrate sensors every few months.

6. Connect the sensor lead(s) to the module at the base of the controller (pH = blue), (ORP = yellow).



**Figure 19. pH/ORP Connection Ports**

## 5.6 Install the pH Down Intake and Injection lines.

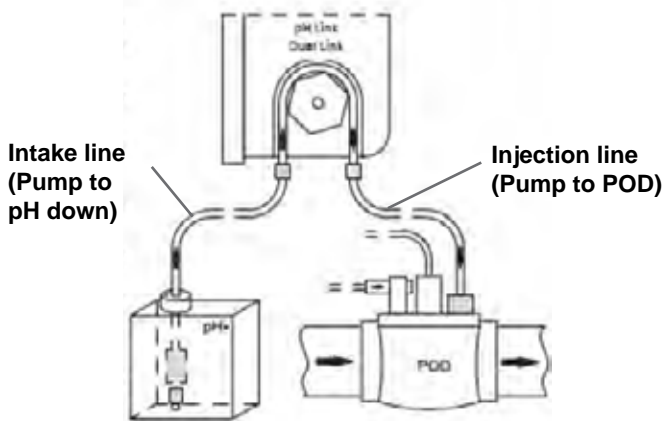
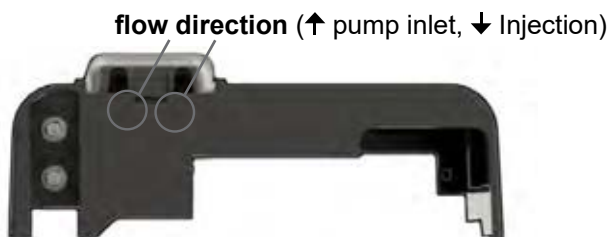

**Figure 20. pH- Pump Configuration**

The pump rotates in a clockwise direction. Acid is fed into the left side of the pump (via the Intake line) and injected into the POD from the right side (via the Injection line).

**CAUTION:** For safety reasons, install the Injection line before the Intake line to ensure pH is not accidentally dosed into the system before all connections are made.

Never store acid directly underneath any equipment as fumes will cause corrosion and resulting damage can void your warranty. It is recommended to store your acid container in a safe, protected well ventilated area.



**Figure 21. pH- Pump Ports**

### 5.6.1 Install the Injection Line

1. Remove the protective cover from the pump.
2. Cut a section of the plastic tubing that has adequate length to reach from the injection valve at the pump to the non-return valve on the POD.
3. Remove the threaded cap from the pump outlet (right).
4. Thread tubing through the hole in the cap, connect the tubing to the nipple on the module and reattach the threaded cap.

**NOTE:** For a better fit, soften both ends of the tubing by immersing in warm water.

5. Remove the threaded cap from the POD intake valve.
6. Thread tubing through the hole in the cap, connect the tubing to the nipple on the POD and reattach the threaded cap.

### 5.6.2 Install the pH Down Intake Line

1. Cut a section of the plastic tubing that has adequate length to reach from the pH down reservoir to the pump.
2. Remove the threaded cap from the pump inlet (left side).
3. Pass one end of the tubing through the threaded cap and attach tubing to the nipple on the pump inlet.
4. Remove the cap from the pH down container.
5. Select the appropriate size acid cap (included), either 5 L or 15/20 L.
6. Thread tubing through the hole in the cap through the ceramic weight.
7. Remove the nut from the blue compression fitting.
8. Pass the tubing through the nut and attach it to the nipple on the compression fitting.
9. Reattach the threaded nut.
10. Put the weighted end of the hose into the pH down reservoir.
11. Secure the pH down cap tightly on the container.
12. Replace the protective cover on the pump.



**Figure 22. pH- Intake Connections**

## 5.7 Calibration Procedure

To maintain accurate and reliable operation, the sensors must be calibrated before using the controller with pH/Dual Link module. After initial calibration, it is recommended to recalibrate sensors every few months.

### 5.7.1 Clean the Sensor(s)

Sensor(s) must be cleaned before calibration, including prior to initial use after installation.

1. Turn off the filter pump.
2. Close all valves.
3. Remove the sensor and the sensor holder from the POD.
4. Rinse the sensor with tap water for 1 minute. Shake off excess water.

**NOTE:** To avoid damaging the active sensor, do not rub or dry with a cloth.

5. Brush the junctions and metal strip using a toothbrush for 1 minute.



**Figure 23. Cleaning Probe**

6. Prepare a diluted hydrochloric acid solution by pouring 50 mL tap water into 1 mL (10 drops) of commercially-available hydrochloric acid (HCl 37%).

#### **⚠ WARNING**

- Hydrochloric acid is a hazardous chemical that may cause burns, lesions, and irritations. Handle with extreme care using protective equipment (gloves, goggles, coveralls). Refer to the substance SDS sheet for more information.
- Always pour acid into water.
- Once cleaning is complete, dispose of the solution according to standard in effect in the country of use.

7. Wash the sensor in the diluted hydrochloric acid solution for 2 minutes.
8. Rinse sensor in clean tap water for 1 minute. Shake off excess water.

### 5.7.2 Calibrate the pH Sensor

The pH sensor (blue) can be calibrated in 1 or 2 points. We recommend 2-point calibration for a more reliable measurement throughout the season.

1. Turn on power to the controller.
2. Turn off the pool pump and close valves as necessary to isolate the cell and sensors.
3. Unscrew the pH sensor from the POD.
4. Rinse the end of the sensor with tap water. Shake off excess water. Do not touch the glass bulb at the end of the pH sensor.
5. Start 1 or 2 point calibration via the controller User Interface, see Section 8.3 For details.
6. If calibration is unsuccessful, see Section 11. Troubleshooting.

### 5.7.3 Calibrate the ORP Sensor

1. Verify power to the controller is on, pump is off, and valves are closed isolating the cell and sensors.
2. Unscrew the ORP sensor from the POD.
3. Rinse the end of the sensor with tap water. Shake off excess water. Do not touch the end of the ORP sensor.
4. Place the probe in a sample of ORP 470 mV buffer solution for one minute.
5. Start calibration via the controller User Interface, see section 8.4.
6. Once calibration is complete, replace the sensor on the POD. If calibration is unsuccessful, see Section 11.

## Section 6. Prepare and Balance the Pool

There are some critical factors to be aware of when installing and setting up a MagnaPool® hydroxinator in order for optimal performance. It is important that you balance the water to ensure that all levels are within normal ranges.

### 6.1 Set up the Media Filter

Use the supplied plastic cover to stop media entering the central lateral and add enough water to cover the laterals before adding the glass media.

Fill roughly 1/3 of the filter with Zodiac Coarse Glass to cover the laterals. The remainder of the filter need to be filled with Zodiac Fine Glass to roughly 100 - 150mm from the top.

### 6.2 Fill and Balance the Pool

After filling the pool with “tap” water, it is important that you balance the water. This will involve ensuring that all levels are within normal ranges. Perform regular startup procedures, whether concrete or fibreglass.

**Pre-startup steps are critical to ensuring trouble-free installation and easy ongoing maintenance of the MagnaPool:**

- If it is a concrete pool, pay particular attention to your calcium hardness at the balancing stage before adding any minerals. Ensure your calcium levels are between 150-400ppm. If your pool is fibreglass, calcium should be set at manufacturers recommended levels.
- Ensure your alkalinity level is around 100ppm and that your pH is stable between 7.2 - 7.6 for concrete pools. If fibreglass, please abide by manufacturers specifications (usually 7.0 - 7.2).

### 6.3 Starting the System

Add the required bags of minerals to the water. (See Table.)

Turn on the filter pump and Hydroxinator and set it to operate on boost mode. This will kick start the sanitizing and hydroxination process.

Leave the filtration system running for at least 24 hours in boost mode, then press Boost again to allow for 48 hours of complete sanitizer production and circulation.

After you have implemented the boost cycle twice, allow the hydroxinator to operate in normal timer mode.

20,000 L	12 bags
30,000 L	18 bags
35,000 L	21 bags
40,000 L	24 bags
45,000 L	27 bags
50,000 L	30 bags
55,000 L	33 bags
60,000 L	36 bags
65,000 L	39 bags
70,000 L	42 bags

**NOTE:** 6 bags x 10,000L

**Table 6. Mineral Requirements**

### 6.4 First Two Weeks

For the first two weeks there are a number of things to be aware of:

- The water may go cloudy or even discolour at first and a film of foam can occasionally appear on the surface. This is completely normal and part of the settling-in phase. This is the hydroxination process in action and may last for a day or two. It is best not to swim during this time, however it is not harmful in any way.
- It is advised to remove any pool cleaners if there is foam present. After the water has cleared, a cleaner may be placed in the pool. **NOTE:** During the first 2 weeks, most cleaners will not adhere to the walls and surface of the pool. This is normal and the cleaner will resume normal operation after 2 weeks.
- Chlorine may be difficult to test for during the first 2 weeks. Please do not be alarmed. Chlorine is present and it is safe to swim. The initial set-up phase will mask chlorine testing.
- After 2 weeks, it may be necessary to perform a short backwash to remove the initial debris that has been captured. Check the pressure in the filter and backwash if required.



## 6.5 Water Chemistry Table

Test and maintain correct water balance throughout the season, according to the table.

Chemistry Before Adding MagnaPool Minerals:						
	Free Chlorine (ppm)	pH	Total Alkalinity (ppm)	Calcium Hardness (ppm)		
Ideal range	1 +	7.2 - 7.6 Concrete 7.0 - 7.2 Fibreglass*	80 - 120	150 - 400 Concrete <100 Fibreglass*		
To Increase	Add Chlorine or increase equipment output	Add Soda Ash (use pH Up)	Add Sodium Bicarbonate (use Alkalinity Up)	Add Calcium Chloride (Use Calcium Up)		
To Decrease	N/A	Add Acid (use pH Down or Liquid Acid)	Add Acid (use pH Down or Liquid Acid)	Partially drain and refill pool		

NOTE: Test all equipment sensors quarterly.  
\* For fibreglass always abide by manufacturers recommendations for saltwater pools regarding Alk and pH

Chemistry After Adding MagnaPool Minerals:						
	Free Chlorine (ppm)	pH	Total Alkalinity (ppm)	Total Hardness (ppm)	Cyanuric Acid	Salinity Level
Ideal range	After 2 weeks 1 - 3	7.2 - 7.6 Concrete 7.0 - 7.2 Fibreglass*	80 - 120	500 -1000 (NOTE: Total Hardness not Calcium Hardness)	30 - 50	5,000 - 5,500 (at start)
To Increase	Add Chlorine or increase equipment output	Add Soda Ash (use pH Up)	Add Sodium Bicarbonate	Add Calcium Chloride (Use Calcium Up)	Add CYA (use UV Blockout)	Add MagnaPool Minerals
To Decrease	N/A	Add Acid (use pH Down or Liquid Acid)	Add Acid (use pH Down or Liquid Acid)	Partially drain and refill pool	Partially drain and refill pool	Partially drain and refill pool

Table 7. Water Chemistry

## 6.6 pH Regulation Principle

The amount of chlorine needing to be produced is dictated by the pH level in the pool. As the pH level rises, the amount of chlorine must be increased to compensate, see Table 6.

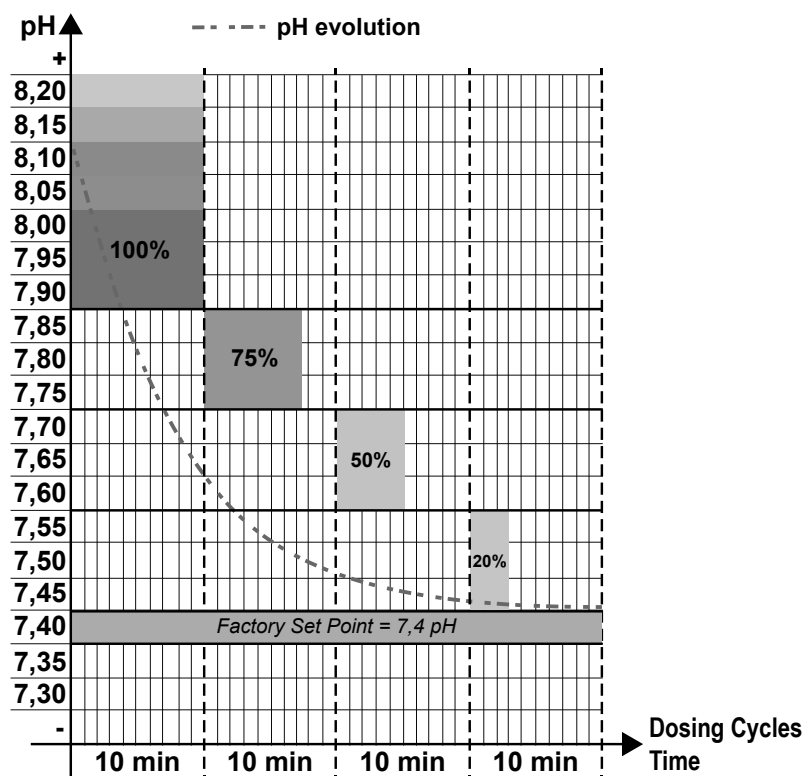

Table 8. pH Evolution



## 6.7 Stabilizer (Cyanuric Acid)

A pool has a stabilizer content of 30 ppm and a pH of 7.4:

1 ppm free chlorine = 700 mV

➔ Therefore, the user can set their chlorination requirement to 700 mV to maintain a level of 1 ppm in the pool

If the level of stabilizer increases to 90 ppm, the ORP reading will be false:

1 ppm free chlorine = 500 mV

➔ If the user keeps his setpoint at 700 mV, he will end up chlorinating up to 5 ppm!

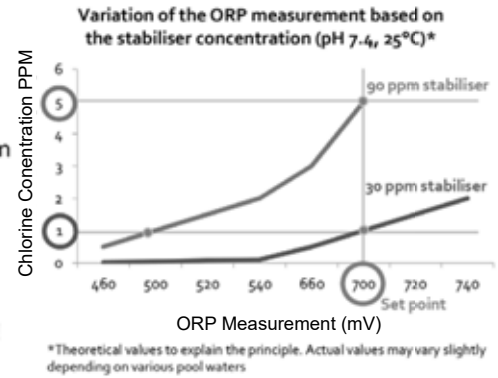

IT IS THEREFORE ESSENTIAL TO MONITOR THE STABILIZER LEVEL IF AN ORP REGULATOR IS INSTALLED

30 PPM IS THE RECOMMENDED LEVEL FOR SWIMMING POOLS IN AREAS WITH STRONG SUNLIGHT

THIS IS UNNECESSARY IN OTHER CASES, ESPECIALLY IF ORP REGULATION IS USED

## Section 7. Operation

### 7.1 User Interface Overview

#### CAUTION

Before activating the chlorination function ensure that all minerals added to the pool have completely dissolved.

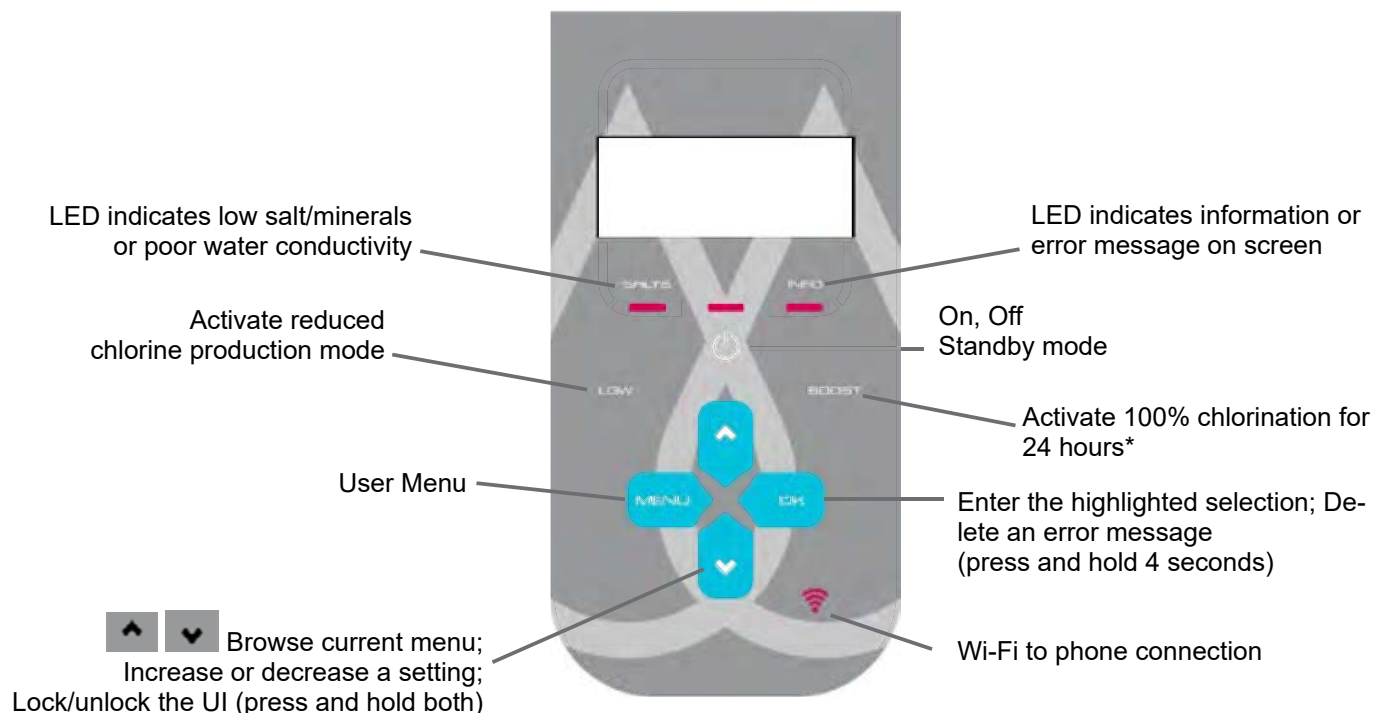

\*The filter pump will also operate if filtration pump is connected to the controller



Figure 24. Controller User Interface

## 7.2 Initial start-Up



The following setting must be configured at the initial start up of the device. Settings can be changed or updated at a later time using the general menu, details can be found in Section 8.

From factory, the hydroxination is set at 50 %. It can be set between 0 and 100 % in 10 % increments from the “main screen” by pressing ▲▼. The set value is valid until the next modification.

### 7.2.1 System Power



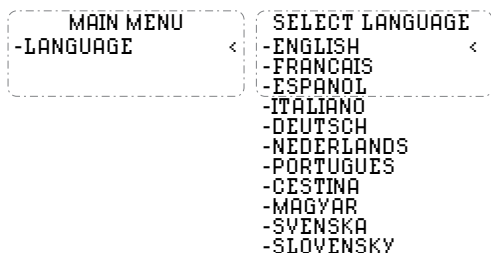

1. Press  to enter Standby mode.
2. Press  again to start hydroxination and filtration.
3. Press and hold  for 3 seconds to turn the controller off.

### 7.2.2 Language

1. Press .
2. Use ▲▼ to select “Language” then press .
3. Use ▲▼ to browse language the options.
4. Press  to make a selection.



### 7.2.3 Set Clock

1. Press .
2. Use ▲▼ to select “Programming” then press .
3. Use ▲▼ to select “Clock” then press .
4. Use ▲▼ to set hour then press .
5. Use ▲▼ to set minutes then press .

NOTE: Press and hold ▲ or ▼ to increment time by 10.

6. Press  to exit.

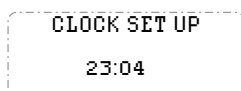
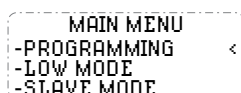

### 7.2.4 Boost Mode

In some cases, the pool may require a higher than normal hydroxination level such as in cases of high use, poor weather or at the start of the season. Boost mode is used to increase the chlorine level quickly.

Boost mode lasts for 24 cumulative hours at 100% production output. If the program is set to perform hydroxination 12 hours per day, Boost mode will be active for 12 hours on the first day and 12 hours on the second day. If the filter pump is connected to the controller, the filter pump will operate in Boost mode also. The controllers operating times including filtration schedules are temporarily ignored for the duration of the Boost mode. Once Boost mode completes, the controller and filter pump will resume programmed operations.

**NOTE:** If the device is equipped with a Dual Link module, the Boost mode will not take the ORP value into account. The Boost mode takes priority over the ORP regulation

1. Press .

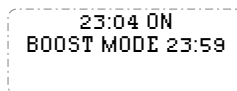



2. If the controller is in Low/Cover mode you will need to confirm that you want Boost mode to override Cover or Low mode settings.

### 7.2.5 Low Mode

Low mode is designed to reduce chlorine production in situations where the pool is covered or when pool use is limited. Chlorine production needs will be lower when pool use is low and/or when pool water is not exposed to UV rays etc.

Low mode output can be set in the main menu settings for Low mode. Low can be set from 0%-30% in 10% increments. Programs are still active while the controller is in Low/Cover mode.

1. To manually enter Low mode press .
2. To exit Low mode press  again.

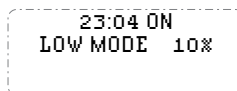

### 7.2.6 Cover Mode

If the pool is equipped with a compatible electric roller cover, this can be connected to the controller in order to automatically reduce hydroxination upon closing the cover, this is known as Cover mode, see Table 5 and Figure 10 for wiring details. Hydroxination will resume at the level determined by the programming upon opening the compatible electric cover.

Cover mode output can be set in the main menu settings for Low mode. Low can be set from 0%-30% in 10% increments. Programs are still active while the controller is in Low/Cover mode.

Check that the cover is compatible and connected to the hydroxinator.

Cover mode will automatically be activated when the cover is closed. The Cover mode message and the output percentage are displayed on the screen.

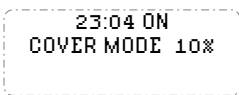

23:04 ON  
COVER MODE 10%

Cover mode will stop as soon as the cover is completely open.

If the controller is equipped with a Dual Link module we do not recommend connecting the Cover mode. More specifically, hydroxination is managed via the Dual Link module. In cases where the Cover mode is connected in the presence of a Dual Link module: hydroxination will take place upon closing the roller cover, even if the ORP measurement is greater than the setpoint value.

### 7.2.7 Cold Water Protection

In addition to recording and displaying the water temperature, the temperature sensor is used to protect the cell, which is sensitive to cold water.

The temperature displayed on the top left of the home screen will begin to flash at 15°C.

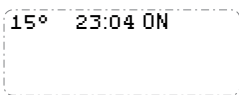

15° 23:04 ON

When water temperature is under or equal to 15°C, chlorine production automatically switches to the level defined in Low/Cover mode.

When water temperature is under or equal to 10°C, chlorine production is stopped. The absence of hydroxination at this temperature is not hazardous, as bacterial development is slowed in cold water.

In addition to the flashing temperature, a “LOW TEMPERATURE” message is alternately displayed.

When the temperature goes over 10°C again, the output percentage will be set to Low/Cover.

When the temperature goes over 15°C again, hydroxination resumes its level of operation configured using programs.

### 7.2.8 Locking the Controller

The controller can be locked, thus deactivating the buttons on the user interface panel. Simultaneously press and hold the ▲ and ▼ buttons for 3 seconds. This function can be accessed from any screen/menu.

Locking the controller automatically returns the user to the home screen. To unlock the controller, press and hold the ▲ and ▼ buttons for another 3 seconds.

## Section 8. Menu and Settings

### 8.1 Filter Pump

Both single and variable speed pumps can be connected to and operated by the controller.

#### 8.1.1 Single Speed Filter Pump

1. Connect the filter pump to the controller at the pump connection point in the high voltage raceway. For Australian installations plug the filter pump into the socket provided on the underside of the control unit see Table 5 and Figure 10 for wiring details.
2. Press **MENU**.
3. Use ▲▼ to select “Filter Pump” then press **OK**.
4. Use ▲▼ to select “Single Speed” then press **OK**.
5. The user interface will prompt “Single Speed Plug to Device”. Use ▲▼ to select “Yes” then press **OK**.

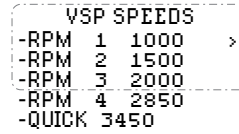
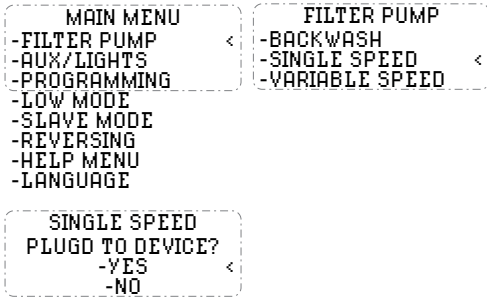

### 8.1.2 Variable Speed Filter Pump

1. The following pump models are compatible: FloPro™ VS, Flopro™ VS AUT
2. Connect the filter pump to the controller at the VSP RS485 connection point in the low voltage raceway, see Table 5 and Figure 10 for wiring details.
3. Ensure the RS485 wires are in the proper order.

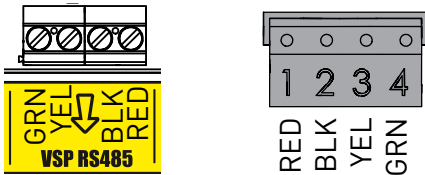

On the Controller      On the Pump

4. Ensure the pump DIP switches are in the correct position as follows:
  - 1 = up
  - 2 = up
  - 3 = down
  - 4 = down
  - 5 = up
5. Press **MENU**.
6. Use **▲▼** to select “Filter Pump” then press **OK**.
7. Use **▲▼** to select “Variable Speed” then press **OK**.
8. The user interface will prompt “Variable Speed Plgd to Device”. Use **▲▼** to select “Yes” then press **OK**.
9. Use **▲▼** to select a speed then press **OK**.
10. Use **▲▼** to adjust the RPM.
11. Once desired RPM is reached, press **OK**.
12. Press **MENU** to exit.

**NOTE:** If multiple VSP timers have a time slot in common : it is the higher RPM that will be operated.

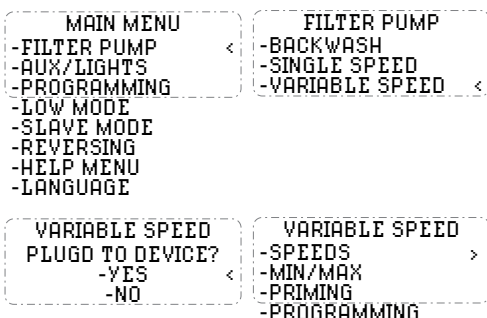

### 8.1.3 Quick Clean

Quick Clean is a backwash mode is used to quickly start/stop the filter pump (single- or variable-speed pump) in order to backwash the filter.

For variable speed pumps, the backwash RPM is set under “Quick”.

1. Select YES to activate filtration.
2. Select NO to stop filtration.

For safety reasons, the hydroxination is stopped during the backwash mode. To avoid emptying the pool, the backwash mode automatically stops after 5 minutes. The variable speed pump RPM is by default set at 3450 rpm (max speed). This can be changed in the priming menu.

## 8.2 Aux/Lights

The hydroxinator is capable of controlling devices in addition to the filter pump. The equipment must be connected to the hydroxinator using the appropriate auxiliary line:

Aux 1: for equipment connected to the high voltage supply (230 V) (not applicable for Australia).

Aux 2: for equipment connected to the low voltage supply (12/24 V).

The following functions are available in the AUX/LIGHTS menu for auxiliaries 1 and 2:

- Turn the equipment on/off
- Program a timer (See section 8.7.6 for details)

For Australian products, in order to control the light transformer, an additional switching box is required. Please contact your local pool care professional for this relay box, item code WW000222.

1. Remove the lower cover from the housing.
2. Attach the 2 x core wires from the switch box to the terminal bar marked ‘AUX 2’.
3. Replace the cover/s.
4. Plug the switch box into any available 240V GPO.
5. Plug the light transformer directly into the socket located in the switch box. This will now control the light directly from the hydroxinator.

## 8.2.1 Assign Lights

1. Press **MENU**.
2. Use **▲▼** to select “Aux/Light” then press **OK**.
3. Use **▲▼** to select “Assign Lights” then press **OK**.
4. Use **▲▼** to select “Aux 2” then press **OK**.
5. Use **▲▼** to select “Yes” then press **OK**.
6. Use **▲▼** to select “White Light” or “Color Light” then press **OK**.
7. Press **MENU** to exit.

```

MAIN MENU
-AUX/LIGHTS <
-PROGRAMMING
-LOW MODE
-SLAVE MODE
-REVERSING
-HELP MENU
-LANGUAGE

AUX/LIGHTS
-ASSIGN LIGHTS >
-AUX 2
-AUX 1
  
```

```

ASSIGN LIGHTS
-AUX 2 <
-AUX 1

AUX SETUP
AUX 2 = LIGHT?
YES >
NO
  
```

```

AUX 2 = LIGHT
-WHITE LIGHT >
-COLOR LIGHT
  
```

## 8.2.2 White Light Operation

1. Press **MENU**.
2. Use **▲▼** to select “Aux/Light” then press **OK**.
3. Use **▲▼** to select “Aux 2/Light” then press **OK**.
4. Use **▲▼** to select “On”, “Off”, or “Set Timers”, then press **OK**.
5. Press **MENU** to exit.

```

AUX 2
-OFF <
-ON
-SET TIMERS
  
```

## 8.2.3 Color Light Operation

1. Press **MENU**.
2. Use **▲▼** to select “Aux/Light” then press **OK**.
3. Use **▲▼** to select “Aux 2/Light” then press **OK**.
4. Use **▲▼** to select desired color, “Off”, “On” or “Define Color”, then press **OK**.
5. If “Define Color” selected, use **▲▼** to select desired color then press **OK**.
6. Press **MENU** to exit.

```

AUX 2 / LIGHT
-OFF <
-ON
-DEFINE COLOR >

COLOR LIGHT
-ALPINE WHITE <
-SKY BLUE
-COBALT BLUE
-CARIBBEAN BLUE
-SPRING GREEN
-EMERALD GREEN
-EMERALD ROSE
-MAGENTA
-VIOLET
-SLOW SPLASH
-FAST SPLASH
-AMERICA
-FAT TUESDAY
-DISCO TECH
  
```

**Note:** Colour sequence is relevant for Zodiac colour lights only. If other manufacturers lights are installed the colour selection will vary

## 8.3 pH Sensor Calibration

The pH sensor may be calibrated in 1 point calibration or 2 point calibration (pH 4 and pH 7); 2 point calibration is recommended.

1. Turn on power to the controller.
2. Turn off the pool pump and close valves as necessary to isolate the cell and sensors.
3. Press **MENU**.
4. Use **▲▼** to select “pH Setup” then press **OK**.
5. Use **▲▼** to select “pH Calibration” then press **OK**.
6. Use **▲▼** to select “1 Point”, or “2 Points”, then press **OK**.
7. Remove the pH sensor from the POD.
8. Insert the pH sensor into the pH 7 buffer solution.
9. Press **OK** while “Start” is selected.
10. Press **OK** while “Go to Step 2” is selected.
11. Rinse the pH sensor with tap water.
12. Insert the pH sensor into the pH 4 buffer solution.
13. Press **OK** while “Start” is selected.
14. Press **OK** while “Continue” is selected.
15. Press **MENU** to exit.

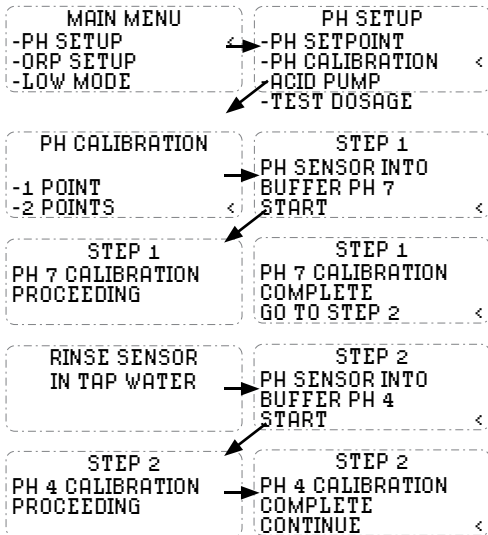

### 8.4 ORP Sensor Calibration

1. Turn on power to the controller.
2. Turn off the pool pump and close valves as necessary to isolate the cell and sensors.
3. Press **MENU**.
4. Use **▲▼** to select “ORP Setup” then press **OK**.
5. Use **▲▼** to select “ORP Calibration” then press **OK**.
6. Remove the ORP sensor from the POD.
7. Insert the ORP sensor into the 470 mV buffer solution.
8. Press **OK** while “Start” is selected.
9. Press **MENU** to exit.

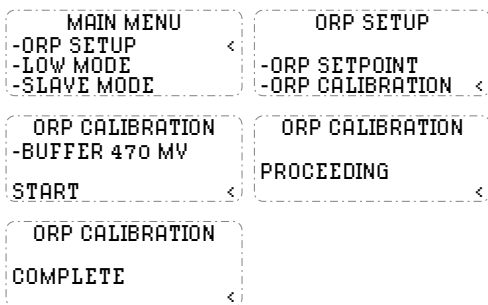

## 8.5 Setpoint(s)

Current setpoints are displayed on the Home screen whenever the controller is ON.

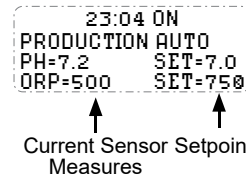

### 8.5.1 Establish the pH Setpoint

Establishing the pH setpoint determines when acid will be added to the system to decrease the pH of the water.

1. Press **MENU**.
2. Use **▲▼** to select “pH Setpoint” then press **OK**.
3. Use **▲▼** to select value then press **OK**.
4. Press **MENU** to exit.

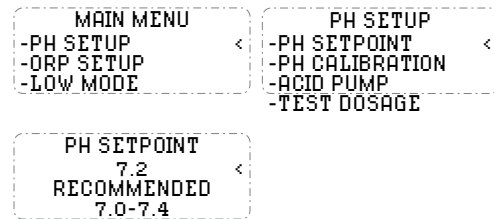

- Default pH setting is 7.2.
- Use **▲▼** to change the setpoint by increments of 0.1.
- pH setpoint range is from 6.8 (min) to 7.6 (max).

### 8.5.2 Establish the ORP Setpoint

Establishing the ORP setpoint determines when chlorine should be produced by the system to chlorinate the water. Free chlorine level should be checked every few days after initial installation.

1. Press **MENU**.
2. Use **▲▼** to select “ORP Setup” then press **OK**.
3. Use **▲▼** to select “ORP Setpoint then press



OK

- Use ▲▼ to select value then press OK.
- Press MENU to exit.

MAIN MENU -PH SETUP -ORP SETUP -LOW MODE	ORP SETUP -ORP SETPOINT -ORP CALIBRATION
---	--

TO AVOID ORP ISSUES CHECK CYANURIC ACID >30 PPM	ORP SETPOINT 700 MV RECOMMENDED 650-750 MV
---	---

- Default ORP setting is 700 mV.
- Acceptable range = 600 mV (min.) - 900 mV (max)

## 8.6 Prime and Test the pH Dosing Pump

The dosing pump is deactivated during the first 8 hours of the device in order to prevent acid exposure during installation. The pH dosing pump can be directly activated directly in order to perform a five-minute operating test.

### ⚠ WARNING

- Hydrochloric acid is a hazardous chemical that may cause burns, lesions, and irritations. Handle with extreme care using protective equipment (gloves, goggles, coveralls). Refer to the substance SDS sheet for more information.
- Always pour acid into water.
- Dispose of the solution according to standard in effect in the country of use.

- Press MENU.
- Use ▲▼ to select "pH Setup" then press OK.
- Use ▲▼ to select "Test Dosage" then press OK.  
The acid pump will perform a five-minute operating test.
- Press OK while "Start Test" is selected to begin.
- Press OK while "Stop Test" is selected to cancel.
- Press MENU to exit.

MAIN MENU -PH SETUP -ORP SETUP -LOW MODE	PH SETUP -TEST DOSAGE
---	--------------------------

CHECK ACID CONNECTIONS START TEST	ACID TEST PROCEEDING STOP TEST
--------------------------------------	-----------------------------------

- Pump stops automatically upon completion of the five-minute test.
- To prevent acid injection when it is not required: It is possible to stop the pH dosing pump for 8 hours through the "pH Setup" Menu.

## 8.7 Programming/Timers

The controller has two internal operating timers. The timers are used to define the length of time for the filter pump to operate, and the length of time for the Hydroxinator to produce chlorine. This offers the user the advantage of running their variable speed pump longer at lower flow rates, without having the hydroxinator producing the whole time.

In order to complete the timer program, it is necessary to enter and validate both ON and OFF times. If no timer is set, the filtration and / or hydroxylation will run continuously

The filtration operating times must be sufficient to correctly treat the water.

**Example** - single speed pump:

In Season filtration time: 8-10 hours per day.

Off Season filtration time: 4-5 hours per day.

**Example** - variable speed pump (when running at lower speeds):

In Season filtration time: 12-14 hours per day  
In Season HYDROX time: 8-10 hours per day

Off Season filtration time: 10-12 hours per day  
Off Season HYDROX time: 4-5 hours per day

Once validated, The hydroxinator will adopt the same timers as the filtration pump. The hydroxylation time must be equal or shorter than the filtration time. The device will not accept a hydroxylation timer longer than or outside the programmed filtration time.

### 8.7.1 Reset Timers

- Press MENU.
- Use ▲▼ to select "Programming" then press OK.
- Use ▲▼ to select "Reset Timers" then press OK.

The selected timers will be reset to 00:00.

### 8.7.2 Operation With an External Timer

In order for the controller to operate with an external timer. All controller programs must be cleared and the device must be on. After the connection to the external timer is made, turn the controller off then back on again.



### 8.7.3 Single Speed Programming

1. Press **MENU**.
2. Use **▲▼** to select "Programming" then press **OK**.
3. Use **▲▼** to select "Filter Pump" then press **OK**.
4. Use **▲▼** to select "Pump Timer 1" or "Pump Timer 2" then press **OK**.
5. Use **▲▼** to select the hour for the filtration on time then press **OK**.
6. Use **▲▼** to select the minutes for the filtration on time then press **OK**.
7. Use **▲▼** to select the hour for the filtration off time then press **OK**.
8. Use **▲▼** to select the minutes for the filtration off time then press **OK**.
9. Press **MENU** to exit.

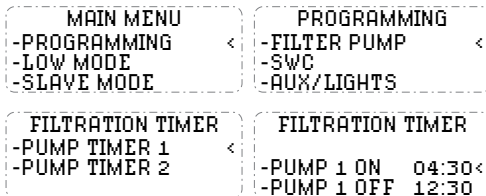

10. When a filtration program has been confirmed the letter "P" is displayed on the top right of the screen.

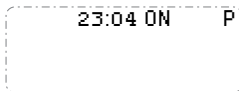

Manual activation of the device (pressing **⏻**) takes priority over the timer. If no filter pump is connected, the controller will only start hydroxination. If a single speed filter pump has been connected the filter pump will start along with hydroxination. If a variable speed pump filter pump has been connected the filtration pump will run along with the hydroxination at its set RPM 1 speed. All programs will still be valid and will resume normal operation the next cycle.

### 8.7.4 Variable Speed Programming

1. Press **MENU**.
2. Use **▲▼** to select "Programming" then press **OK**.
3. Use **▲▼** to select "Filter Pump" then press **OK**.
4. Use **▲▼** to select "Timer Speed (1-4)" then press **OK**.
5. Use **▲▼** to select the hour for the filtration on time then press **OK**.
6. Use **▲▼** to select the minutes for the filtration on time then press **OK**.
7. Use **▲▼** to select the hour for the filtration off time then press **OK**.

8. Use **▲▼** to select the minutes for the filtration off time then press **OK**.
9. Press **MENU** to exit.

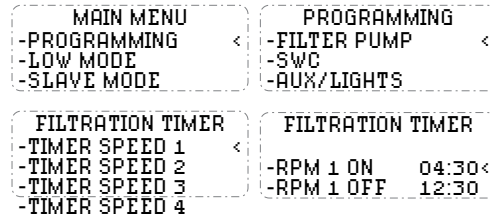

10. When a filtration program has been confirmed the letter "P" is displayed on the top right of the screen.

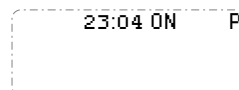

Variable speed filtration timers 1 and 2 are linked to the Hydroxinator programs. Once validated, these programmed times are also set as HYDROX timers 1 and 2.

### 8.7.5 Hydroxinator Programming

If a filtration program has been set, the hydroxination program will be identical to the filtration program(s) by default. They can be changed, however the hydroxination program(s) cannot be activated outside of the filtration Program(s) for safety reasons.

1. Press **MENU**.
2. Use **▲▼** to select "Programming" then press **OK**.
3. Use **▲▼** to select "HYDROX" then press **OK**.
4. Use **▲▼** to select "HYDROX Timer 1" or "HYDROX Timer 2" then press **OK**.
5. Use **▲▼** to select the hour for the HYDROX on time then press **OK**.
6. Use **▲▼** to select the minutes for the HYDROX on time then press **OK**.
7. Use **▲▼** to select the hour for the HYDROX off time then press **OK**.
8. Use **▲▼** to select the minutes for the HYDROX off time then press **OK**.
9. Press **MENU** to exit.

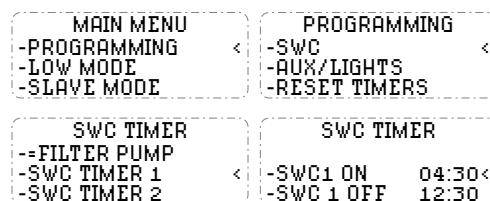

The "T" symbol is displayed in the upper right hand corner of the LCD display on the home screen if the programming is valid.

The “P” symbol is displayed in the upper right-hand corner of the LCD display on the home screen if a valid filter pump and hydroxinator program has been set.



### 8.7.6 AUX/Lights Programming

1. Press **MENU**.
2. Use **▲▼** to select “Programming” then press **OK**.
3. Use **▲▼** to select “AUX/Lights” then press **OK**.
4. Use **▲▼** to select “AUX 1 Timer” or “AUX 2 Timer” then press **OK**.
5. Use **▲▼** to select the hour for the AUX on time then press **OK**.
6. Use **▲▼** to select the minutes for the AUX on time then press **OK**.
7. Use **▲▼** to select the hour for the AUX off time then press **OK**.
8. Use **▲▼** to select the minutes for the AUX off time then press **OK**.
9. Press **MENU** to exit.

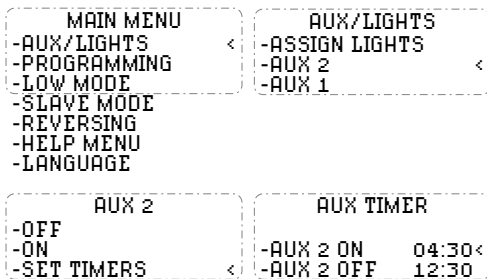

### 8.8 Reversing

#### CAUTION

Adjusting your cell reversal times will result in voiding of warranty. You must consult with Zodiac on 1300 763 021 or your local pool care professional before making any adjustments.

The hydroxinator uses a smart polarity reversal system. Periodic polarity reversal will prevent scaling of the cell plates. The time between each reversal is factory set at 5 hours. This setting is optimal for most water conditions. However, Depending on the calcium hardness of the water, you may need to adjust the reversal time. More calcium in the water will require less time between reversals. Water with less calcium can be given more time between reversals. Shorter reversal times will cause more wear of your cell plates. The polarity reversal interval can be adjusted from 2 to 8 hours in 1-hour steps.

1. Press **MENU**.
2. Use **▲▼** to select “Reversing” then press **OK**.
3. Use **▲▼** to select set hours then press **OK**.
4. Press **MENU** to exit.



During reversal, hydroxination is stopped for a few minutes. No message is displayed on the screen. Normal operation will resume after the reversal.

### 8.9 Slave Mode

Slave mode relinquishes control of the hydroxination function to an external controller. The controller must be connected to the “Slave” connection point in the low voltage raceway see Table 5 and Figure 10 for wiring details.

Boost and Low modes will remain operational from the controller. However, HYDROX programs will be deactivated. Hydroxination output will be maintained at 100%.

1. Connect the external controller at the slave connection point in the low voltage raceway see Table 5 and Figure 10 for wiring details.
2. Press **MENU**.
3. Use **▲▼** to select “Slave Mode” then press **OK**.
4. Use **▲▼** to select “YES” or “NO” then press **OK**.
5. Press **MENU** to exit.

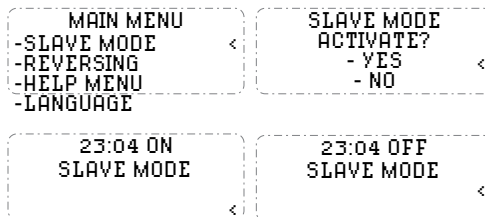

Slave mode only controls the hydroxination. Filtration pump, AUX, lights and other functions are still valid.

Pressing **POWER** will take priority over Slave mode.

If a Dual Link module is installed, the ORP function is overridden by the slave mode. The pH regulation is still valid.

LOW / COVER / BOOST modes takes priority over Slave mode

## 8.10 Help Menu

The hydroxinator will automatically notify you of any problems by displaying error messages. To help with the understanding of these messages, the controller has a troubleshooting assistance menu which gives the meanings and the action to take to solve the problem.

1. Press **MENU**.
2. Use **▲▼** to select "Help Menu" then press **OK**.
3. Use **▲▼** to select the error message then press **OK**.
4. The display will automatically scroll through a certain number of suggested solutions to explain what to do. Once automatic scrolling is complete, the hydroxinator automatically returns to the "Troubleshooting" menu.
5. Press **MENU** to exit.

## Section 9. Inspecting and Cleaning The Electrode

In areas that experience calcium hardness the cell electrode will benefit from cleaning.

1. Switch off the filter pump and chlorine generator, close necessary valves and unplug the cell terminal cap.
2. Unscrew the retaining ring and remove the electrode. If calcium buildup is present, immerse the electrode in cell cleaning solution without immersing the terminals.
3. We recommend using Zodiac Cell Cleaner to clean the electrode. However, you can mix your own by carefully adding one (1) part of Hydrochloric (Muriatic) acid to ten (10) parts water. Stronger solutions will shorten terminal life.
4. Allow the cleaning solution to dissolve the calcium deposits for about 10 minutes. Dispose of the cleaning solution at an approved Council Depot and never into storm water or sewage drains.
5. Rinse the electrode in clean water and re-fit the electrode in the cell housing.
6. Replace the cell head and plug assembly.
7. Reset valves and switches.
8. Turn pump and controller on.
9. Confirm chlorine output and settings on the power pack. Timer programs will be automatically retained.

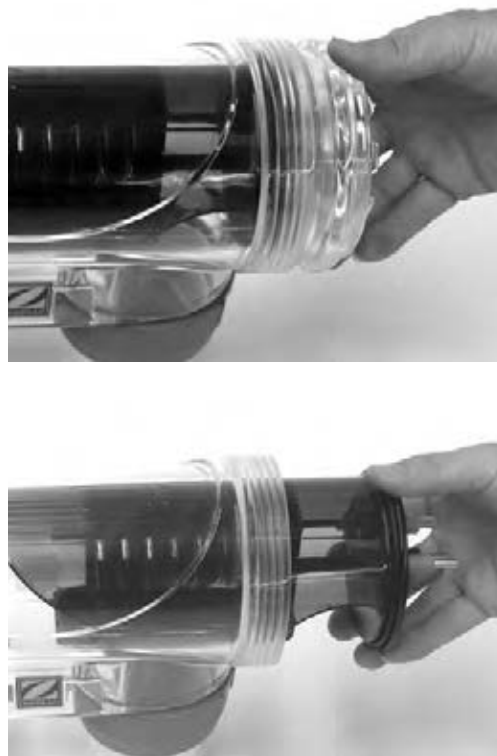

Figure 25. Opening the Cell

## Section 10. Winterizing

The hydroxinator has a protective system which will limit sanitizer production during unfavorable operating conditions, such as cold water or lack of minerals.

Active winterizing leaves the filter pump and hydroxinator running during the winter. This is safe for temperatures above 10°C. If temperatures drop below 10°C, the hydroxination cell needs to be deactivated.

Passive winterization calls for the pool to be shut down. Water levels will need to be lowered and the piping will need to be drained. The cell electrode can be left in place with isolation valves open.

### 10.1 Winterize the pH/ORP Sensors

It is recommended that the plastic protective caps of the pH and ORP sensors are kept to be used as storage containers. The sensors must be stored wet in either a KCl solution (3 mol/L) or tap water. It is preferred that the sensors are stored in the KCL solution if possible.

### 10.2 Reopening the Pool

Required actions:

1. Adjust the water level (too much or too little)
2. Check the water parameters.
3. TAC/TH/pH/Salinity/Chlorine/Stabilizing Agent/Copper/Metals.
4. Adjust the parameters to obtain a balanced, healthy pool, see Section 6.
5. Check the condition of the equipment (pump, filter, hydroxinator, electrolytic cell).
6. Where necessary, check the sensors, clean if needed and re-calibrate.
7. Once the mineral level has reached the required level of 4000ppm and has dissolved in the water, restart the hydroxinator.

## Section 11. Troubleshooting

When there is an error condition, a message is displayed on the screen and the “INFO” LED flashes. When an error is linked to conductivity (low conductivity) the “MINERALS” LED is ON. When the error situation is corrected, the error message and LED illumination ends automatically.

Message	Possible Cause	Solution
NO FLOW CHECK PUMP (“INFO” indicator lit during the production timers)	<ul style="list-style-type: none"> <li>▶ Filter pump failure..</li> <li>▶ Filter and/or the skimmer(s) are dirty.</li> <li>▶ By-pass valve(s) closed.</li> </ul>	<ul style="list-style-type: none"> <li>▶ Check the pump, the filter, the skimmer(s), and the by-pass valve(s). Clean them if necessary.</li> <li>▶ Check the wire connections (flow switch).</li> </ul>
CHECK OUTPUT	<ul style="list-style-type: none"> <li>▶ Cell power cord disconnected or not properly connected to the cell or inside the device.</li> <li>▶ Cell plates worn, calcified or out of order.</li> <li>▶ Internal electronic problem in the control box following an external electric incident.</li> </ul>	<ul style="list-style-type: none"> <li>▶ Switch off the hydroxinator (“Power” button) and switch off the power supply to the control box, then check that all the wires are properly connected (mains power supply, cell, etc.).</li> <li>▶ Replace the cell.</li> </ul>
LOW CONDUCTIVITY (“MINERALS” indicator lit)	<ul style="list-style-type: none"> <li>▶ For models with a temp sensor this error can be caused by low conductivity.</li> <li>▶ Lack of minerals &lt; 4000 ppm due to water loss or dilution (filter backwash, water renewal, rain, leaks, etc.).</li> <li>▶ Can vary depending on the temperature and age of the cell. The voltage across the cell terminals varies in time.</li> <li>▶ Cell calcified, worn, or out of order.</li> </ul>	<ul style="list-style-type: none"> <li>▶ Check water temperature.</li> <li>▶ Check the condition of the cell plates.</li> <li>▶ Measure the mineral concentration in the pool water using a mineral tester or a test strip, then add minerals to the pool to keep the level at 4000 ppm. If you do not know the mineral level or how to test it, contact your retailer.</li> <li>▶ Is the mineral level is correct?</li> </ul>
OVER HEAT (“INFO” indicator lit)	<ul style="list-style-type: none"> <li>▶ The temperature inside the control box is too high, hydroxination is slowed (&gt;85°C) then stopped (&gt; 90°C) if the temperature does not fall back down in order to protect the electric circuits.</li> </ul>	<ul style="list-style-type: none"> <li>▶ If the box is installed outdoors, protect it from direct sunlight.</li> <li>▶ Hydroxination will automatically resume once the temperature has fallen back down.</li> <li>▶ Issue at the controller.</li> </ul>
LOW TEMPERATURE (“INFO” indicator light is lit, the temperature on the display flashes)	<ul style="list-style-type: none"> <li>▶ The water temperature measured by the hydroxinator temperature sensor is less or equal to 10°C; production stops in order to protect the cell.</li> </ul>	<ul style="list-style-type: none"> <li>▶ Hydroxination will automatically resume at the Low Mode hydroxination rate between 10 and 15°C.</li> <li>▶ Hydroxination will automatically resume at the normal hydroxination rate above 15°C.</li> </ul>
NONE (Chlorine production not visible at the cell plates)	<ul style="list-style-type: none"> <li>▶ Hydroxination is in a reversing period.</li> <li>▶ Hydroxination is set at less than 100% and is paused.</li> </ul>	<ul style="list-style-type: none"> <li>▶ Wait and observe, hydroxination should resume.</li> </ul>
<b>Additional messages when a pH Link or Dual Link controller is installed</b>		
pH LOW (“INFO” indicator lit)	<ul style="list-style-type: none"> <li>▶ The pH level is less than 5.</li> <li>▶ The pH sensor is disconnected, dirty, uncalibrated or not working.</li> <li>▶ Alkalinity is low, the pH minus injection may create large pH variations.</li> </ul>	<ul style="list-style-type: none"> <li>▶ Check the pH level in the pool using photometer or a test strip.</li> <li>▶ Check the pH sensor wiring on the control box and on the sensor holder.</li> <li>▶ Check the operation of the sensor using a sensor tester (ask your pool specialist).</li> <li>▶ Clean and calibrate the sensor.</li> <li>▶ Replace the sensor.</li> <li>▶ Check and adjust alkalinity.</li> </ul>
pH DOSING STOP (“INFO” indicator flashing)	<ul style="list-style-type: none"> <li>▶ The pH setpoint has not been reached after 5 cumulative hours of injection.</li> <li>▶ The pH sensor is disconnected, dirty, uncalibrated or not working.</li> <li>▶ The pH minus container is empty.</li> <li>▶ The peristaltic pump is not primed.</li> <li>▶ High alkalinity, acid injection does not help to lower the pH.</li> </ul>	<ul style="list-style-type: none"> <li>▶ Check the pH level in the pool using photometer or a test strip.</li> <li>▶ Check the pH sensor wiring on the control box and on the sensor holder.</li> <li>▶ Check the operation of the sensor using a sensor tester (ask your pool specialist).</li> <li>▶ Clean and calibrate the sensor.</li> <li>▶ Replace the pH container.</li> <li>▶ Test the peristaltic pump (ask your pool specialist).</li> <li>▶ Replace the pH sensor.</li> <li>▶ Lower the alkalinity (ask your pool specialist).</li> </ul>

Message	Possible Cause	Solution
<p>ORP STOP ("INFO" indicator flashing)</p>	<ul style="list-style-type: none"> <li>▶ The ORP setpoint has not been reached after 36 cumulative hours of hydroxination.</li> <li>▶ The ORP sensor is disconnected, dirty, uncalibrated or not working.</li> <li>▶ When cyanuric acid concentration is too high the efficacy of chlorine is highly reduced.</li> <li>▶ When cyanuric acid concentration is too high it lowers the ORP reading from the sensor.</li> <li>▶ pH is too high.</li> <li>▶ When the total chlorine concentration is too high, chloramines will lower the ORP reading of the sensor.</li> <li>▶ The device is not correctly sized for the pool.</li> <li>▶ When the cell is worn, calcified or out of order the electrolysis reaction is not efficient.</li> <li>▶ Daily filtration and hydroxination times are not sufficient</li> </ul>	<ul style="list-style-type: none"> <li>▶ Check the chlorine level in the pool using photometer or a test strip.</li> <li>▶ Check the ORP sensor wiring on the control box and on the sensor holder.</li> <li>▶ Check the operation of the sensor using a sensor tester (ask your pool specialist).</li> <li>▶ Clean and calibrate the sensor.</li> <li>▶ Drain the pool using the main drain in order to lower the cyanuric acid concentration.</li> <li>▶ Proceed to a shock hydroxination (using calcium hypochlorite) to reduce the chloramines concentration.</li> <li>▶ Check the cell conditions.</li> <li>▶ Replace the ORP sensor.</li> <li>▶ Increase daily filtration and SWC timers</li> </ul>

**Table 9. Troubleshooting**

# NOTES



**Zodiac Group Australia**  
219 Woodpark Road,  
Smithfield NSW2164, Australia  
1300 763 021 | [www.zodiac.com.au](http://www.zodiac.com.au)

*ZODIAC® is a registered trademark of Zodiac International,  
S.A.S.U., used under license.  
All trademarks referenced herein are the property of their respective owners.*

©2018 Zodiac Pool Systems, Inc. H0642200\_REVA

